

Dimensions- Small, 1400mm/55.1 Inch

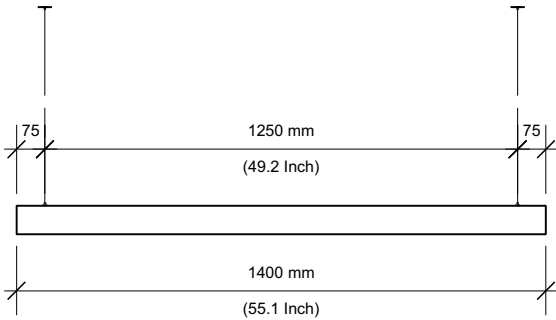

Dimensions- Medium, 1600mm/ 63 Inch

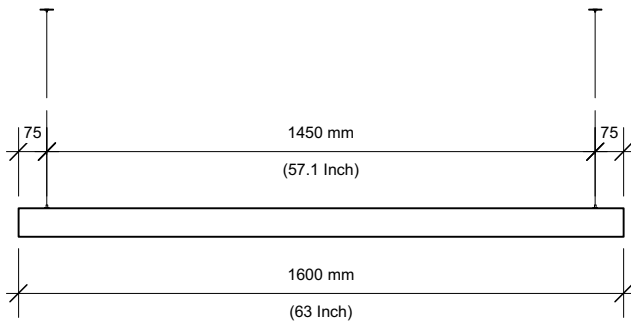

Dimensions- Large, 1800mm/ 70.8 Inch

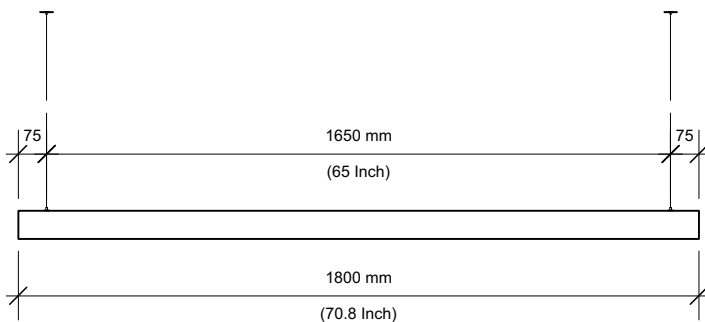

Design by

Thomas Housden

Material & finish

Terracotta extrusion & silicone caps

Dimensions & weight

L.1400mm H.78mm W.51mm, 6kg
(L.55.1inch H.3inch W.2inch, 13.2lb)
L.1600mm H.78mm W.51mm, 8kg
(L.63inch H.3inch W.2inch, 17.6lb)
L.1800mm H.78mm W.51mm, 10kg
(L.70.8inch H.3inch W.2inch, 22lb)

Power supply

EU/UK Mains dimmable driver supplied

USA Standard (fixed output) driver supplied

Optional interfaces/power supplies eg Dali, 1-10V, wall mounted dimmer module, remote control module.

Lamp type & wattage

USA 12v DC LED 20W per metre
2700 or 3000k

IP rating IP20

USA 'damp' rated

Wiring certification

CE, EN60598 IP20

UL Listed 'damp' rated



- Please read these instructions IN FULL and carefully BEFORE commencing assembly and installation.
- We recommend the use of a professional trades person with suitable qualifications for the installation of electrical lamps.
- Install the light in conformity to all relevant local building codes and regulations.
- Products with electronic ballast / drivers must not be installed on the same electrical circuit as products with inductive loads, for example magnetic fluorescent luminaires, motors or ventilators. Inductive loads can generate excessive voltage surges and can damage electronic ballasts.
- Ensure correct connection of cables (positive / negative). The LED will not work if polarity is reversed. Use an electrician!
- This lamp is made of terracotta. Caution should be taken not to hit the lamp with heavy objects that could cause the ceramic to break. The lamp has a bonded aluminium core to prevent structural failure. Sharp parts and fragments may crack off the lamp in the event of impact.
- Always use this lamp either above a table / work surface or at a height above head height. The lamp is solid and heavy so the possibility to walk into the lamp should be avoided.
- Do not hang off the lamp or lean on the lamp to avoid adding weight to the lamp and suspension system. The lamp is designed to take 40kg per suspension cable but the fixing to the ceiling load capacity will depend on the installation and is not designed to support excessive loading.
- If you want to source your own power supply, make sure that this is CLASS 2 and suitable for the LED strip supplied (ie 12 or 24v DC) constant voltage.
- LED light source must be replaced only by the manufacturer or a similarly qualified person.
- If the external cables are damaged, they must be replaced by the manufacturer or a similarly qualified person.
- Used electrical equipment (WEEE) should not be mixed with general household waste. Please recycle. Our products can be dismantled prior to disposal.

Diagram 1

Lamp components

1. 4 inch Raco octagonal ceiling box x2 (not supplied)
2. 'Canopy' (white) x2 with 2 screw holes (screws not supplied)
3. Cable clamps x2 and nuts x2
4. Powered suspension wires 2m x2
(stainless steel outer cover with copper core)
5. Beam cable clamps + nut x2
6. A-Beam extrusion x1
7. Aluminium heat sink + LED x1
8. Diffuser x1
9. Silicone end caps x2

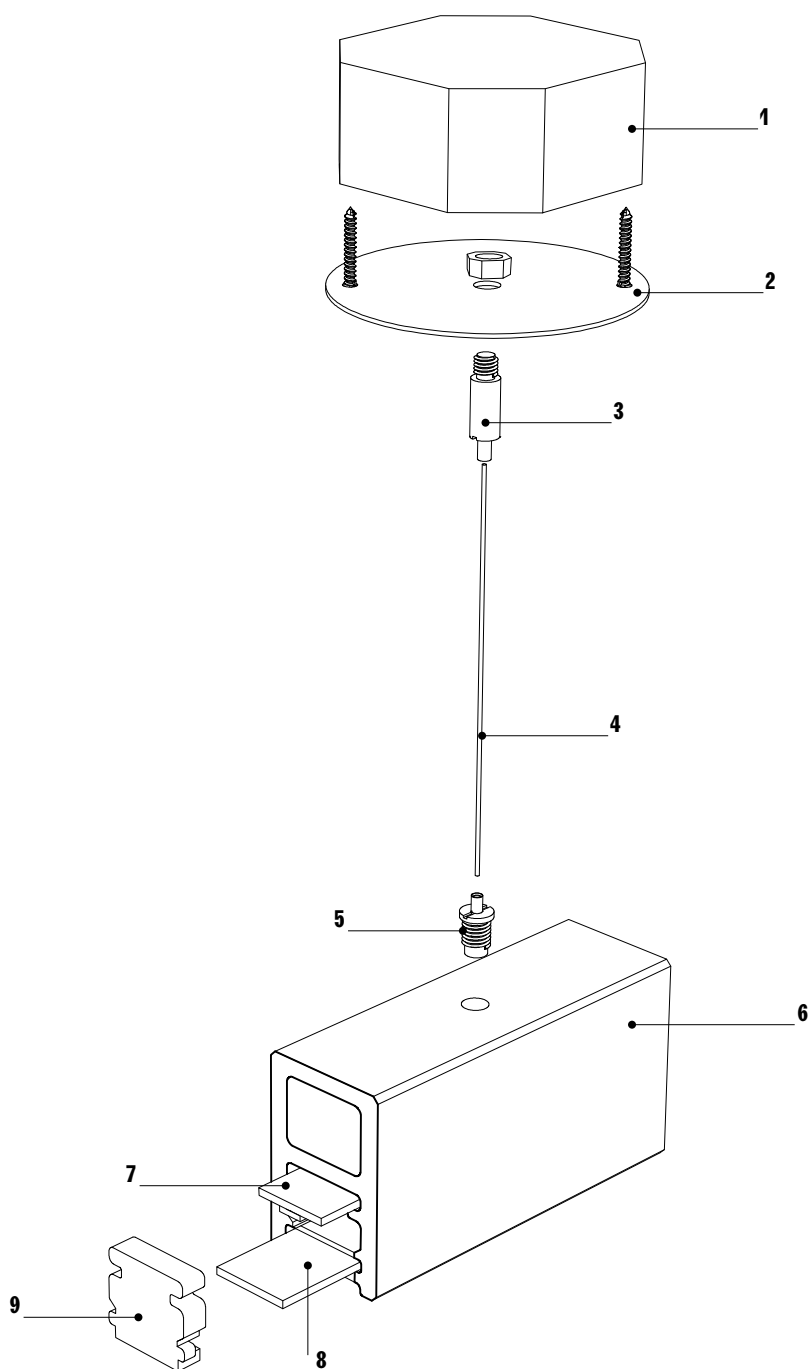

Diagram 2

Spacing Diagram

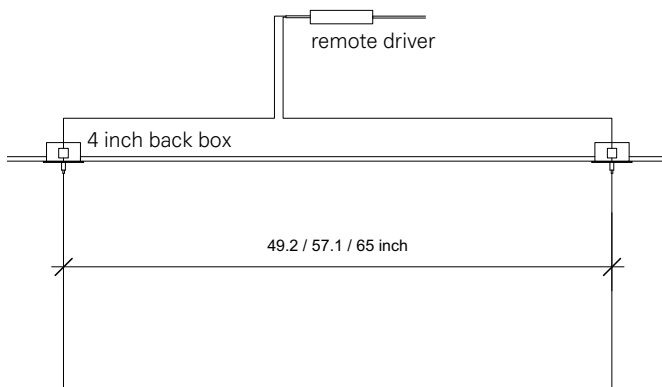
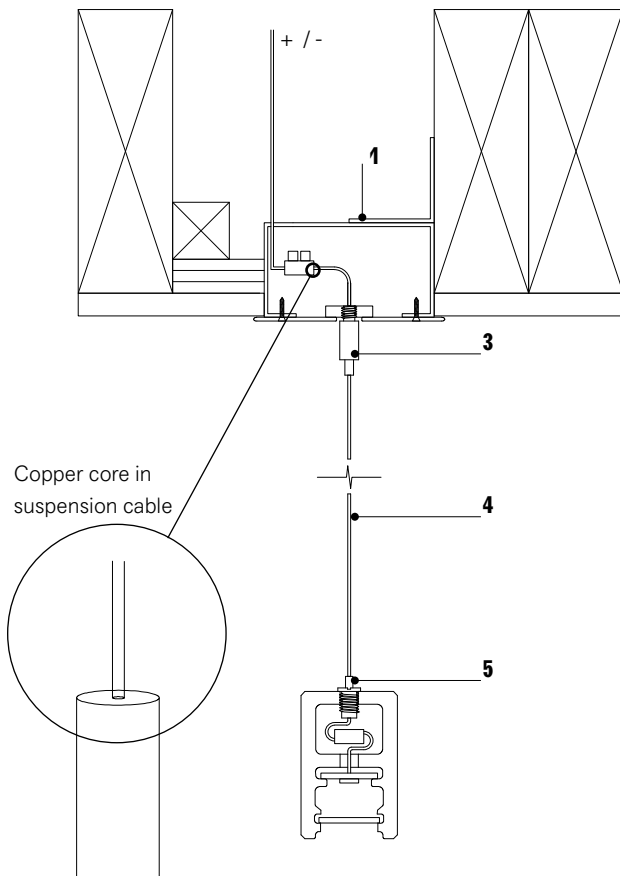

Diagram 3

4 Inch Back Box Connection



Steps

1 Connecting the transformer

Connect the supplied driver/transformer to mains electrics and run a positive feed and negative feed to the required suspension points. Lamp suspension cable centres are 2.9inch in from the ends of the beam so the suspension cables should be located apart by the following dimensions:

55.1inch beam = 49.2inch apart

63 inch beam = 57.1inch apart

70.8 inch beam = 65inch apart

The driver/transformer is to be located max 32 feet from light source. Ensure min 1/16 inch copper core cable runs from transformer to junction box. Ensure this is prepared prior to installing the ceiling.

2 Fitting the back boxes

Ensure two Raco metal back boxes are secured to a suitable structure or substrate to ensure the weight can be hung off the back boxes. Refer to manufacturer details for correct installation.

The back boxes must be located exactly centrally to the suspension hanging points as noted above in step 1.

Note!

- The back boxes will become 12V live / neutral and must therefore NOT be connected to each other through conductive metal such as metal ceiling structures. Ensure the back boxes remain isolated!

3 Securing cable clamp to canopy

Place cable clamp (3) through canopy (2) and secure with the nut. Thread the powered suspension cable (4) through cable clamp (3). The cable will automatically clamp as it is pushed through. To release, push on the nipple whilst pulling on the cable.

4 Connecting the suspension cables to 12V

Once the suspension cable is secured through the cable clamp (3) cut the suspension cable and reveal the tinned copper core conductive cable. Connect this to the 12V driver/transformer power cable (positive / negative) using the provided Wago connector blocks.

Take note of which suspension cable is positive and which is negative to match them correctly at beam level!

Now secure the canopy (2) to the Raco 4 inch back boxes (1). Make sure the screws (not provided) are tight and the canopy is secure.

Diagram 4

Wiring Diagram

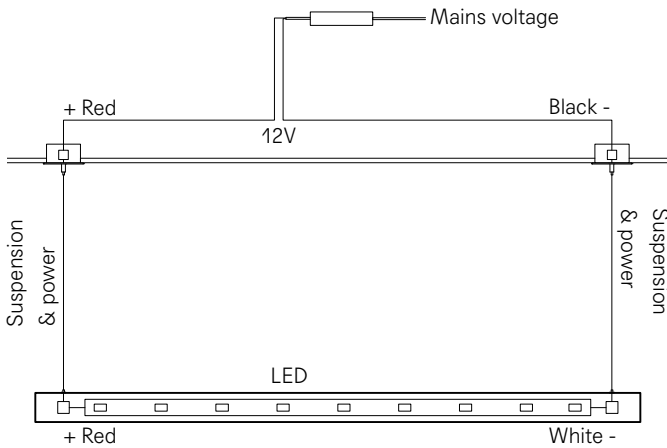

5 Hanging the A-Beam

Now that the suspension and power cables are safely hanging from the ceiling thread the powered suspension cables through the clamps on the A-Beam extrusion (5).

Note!

- Make sure one person holds the ceramic light whilst the other pulls through the cables!
- Make sure the positive power and suspension cable is brought through to the positive LED side of the lam. See Diagram 4!
- Use a spirit level to get the lamp balanced horizontally.

6 Connecting the LED to power

Once the correct height has been achieved cut the excess power and suspension cable. Cut the cable just outbound of the A-Beam top chamber.

Again reveal the inner copper core cable and cut the stainless steel suspension cables short.

Now connect the power and suspension cable to the LED cable. Make sure positive is connected to positive and negative to negative. Make sure the LED cable is sufficiently exposed before inserting in to Wago connector.

7 Hide Connections

Now push the power and suspension cable, Wago connector block and LED cable in to the top chamber.